

UFU / ICIAG
DPV24 – ADUBOS E ADUBAÇÕES
ACIDEZ DO SOLO E CALAGEM
ANTONIO NOLLA

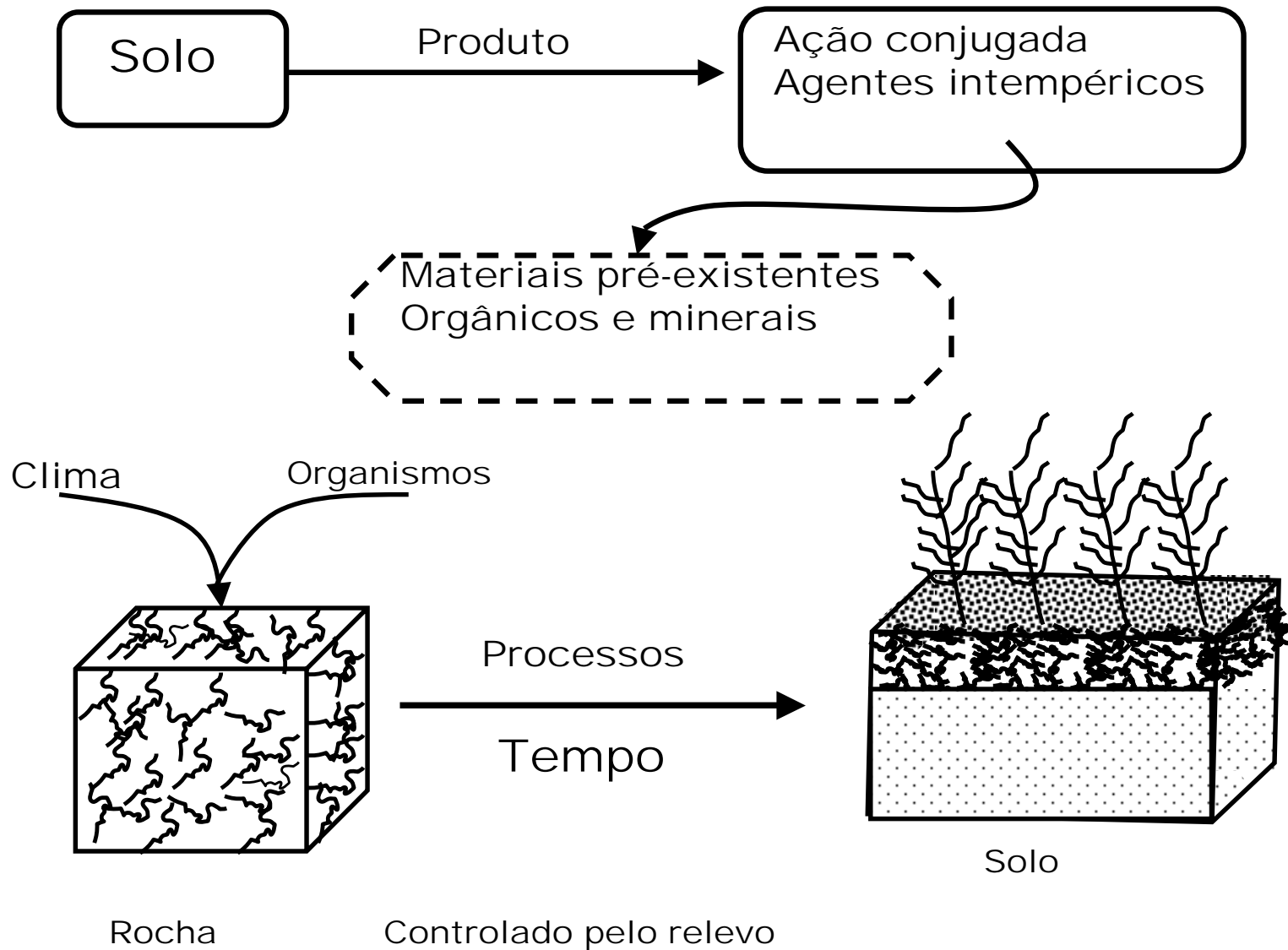

adaptado de Resende et al., 1997

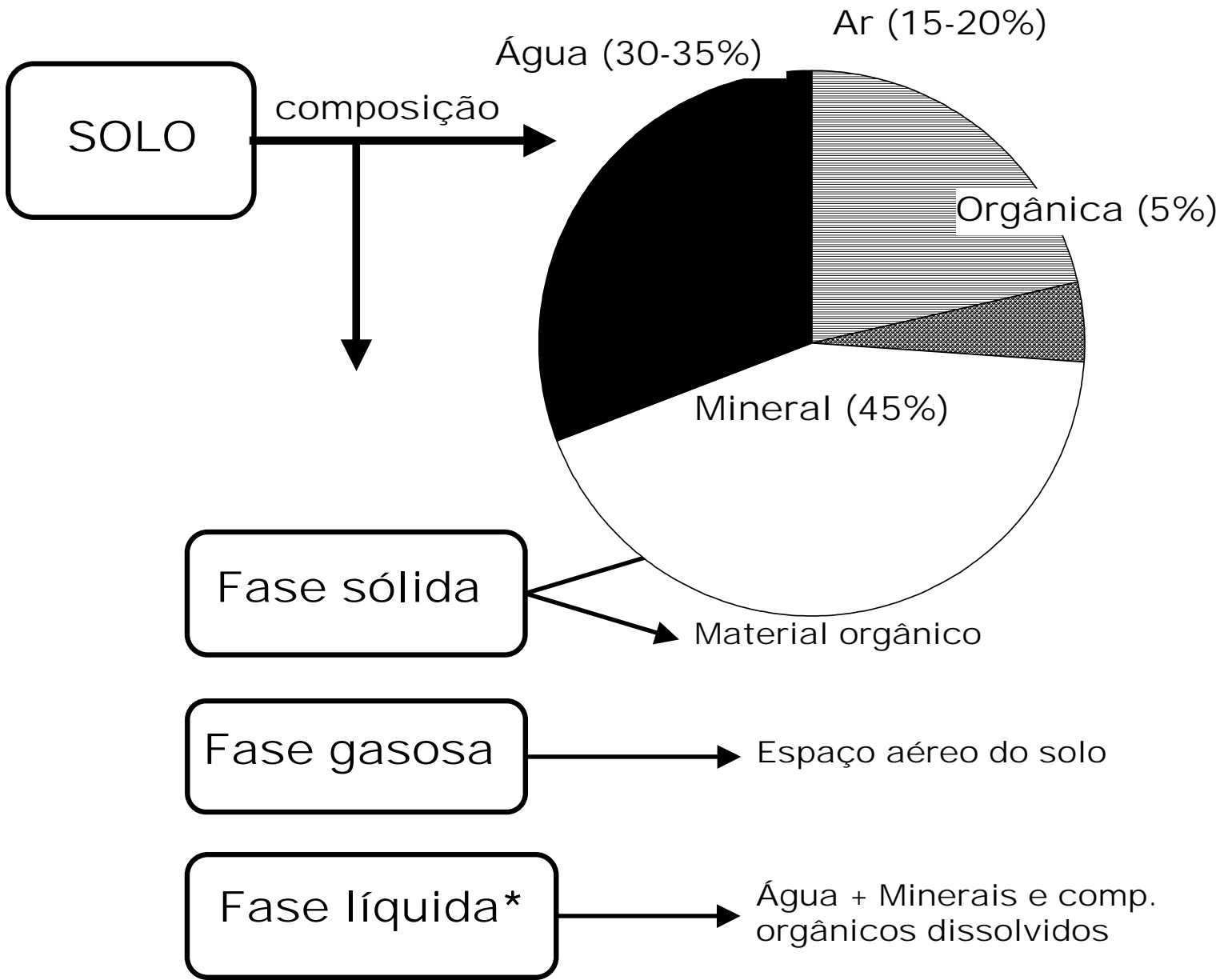

Fonte: Meurer, 2000

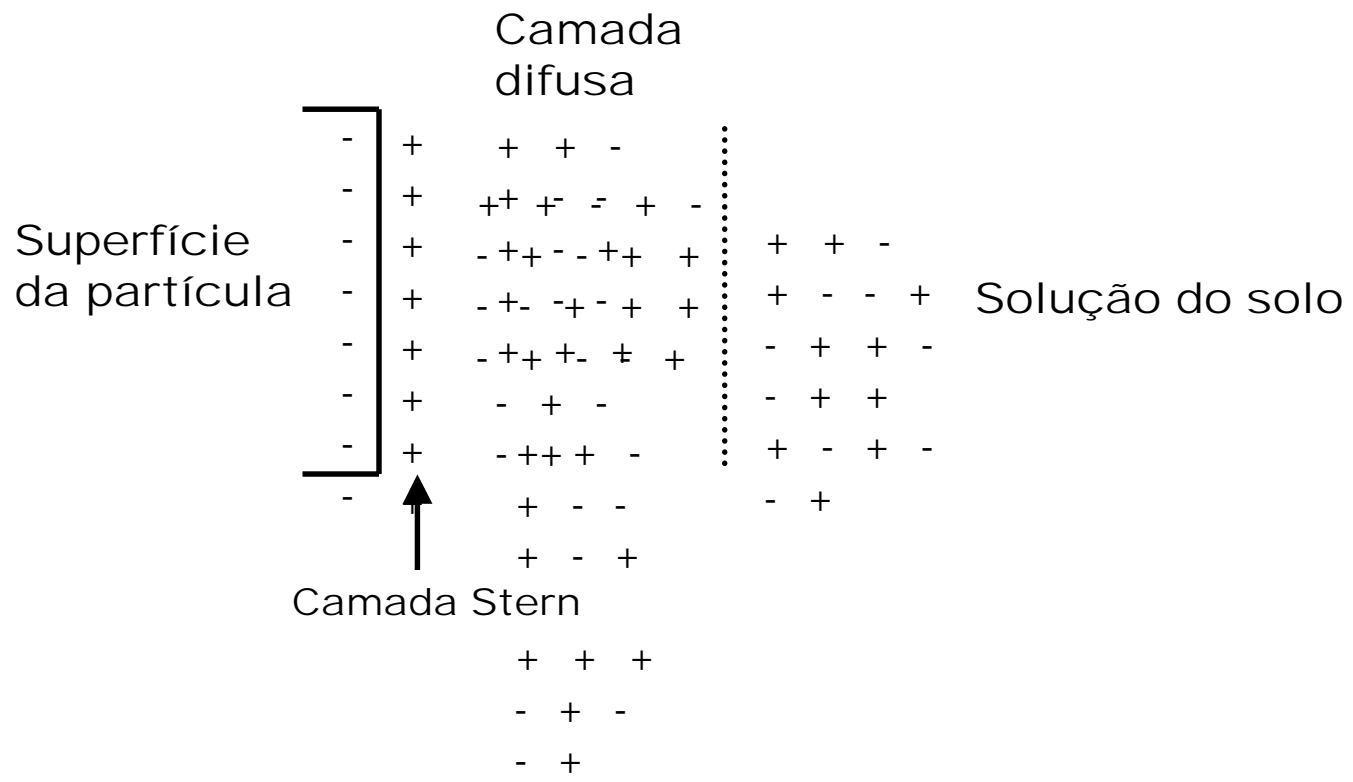
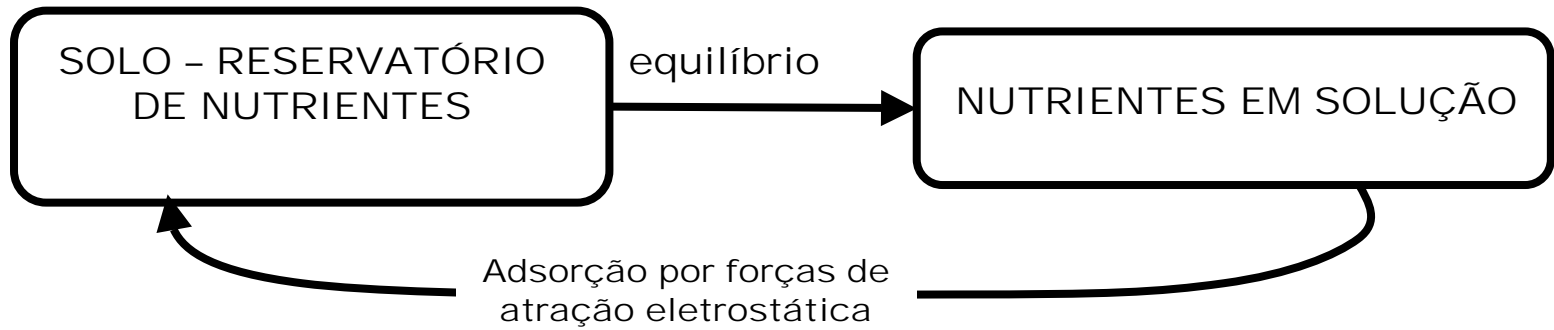

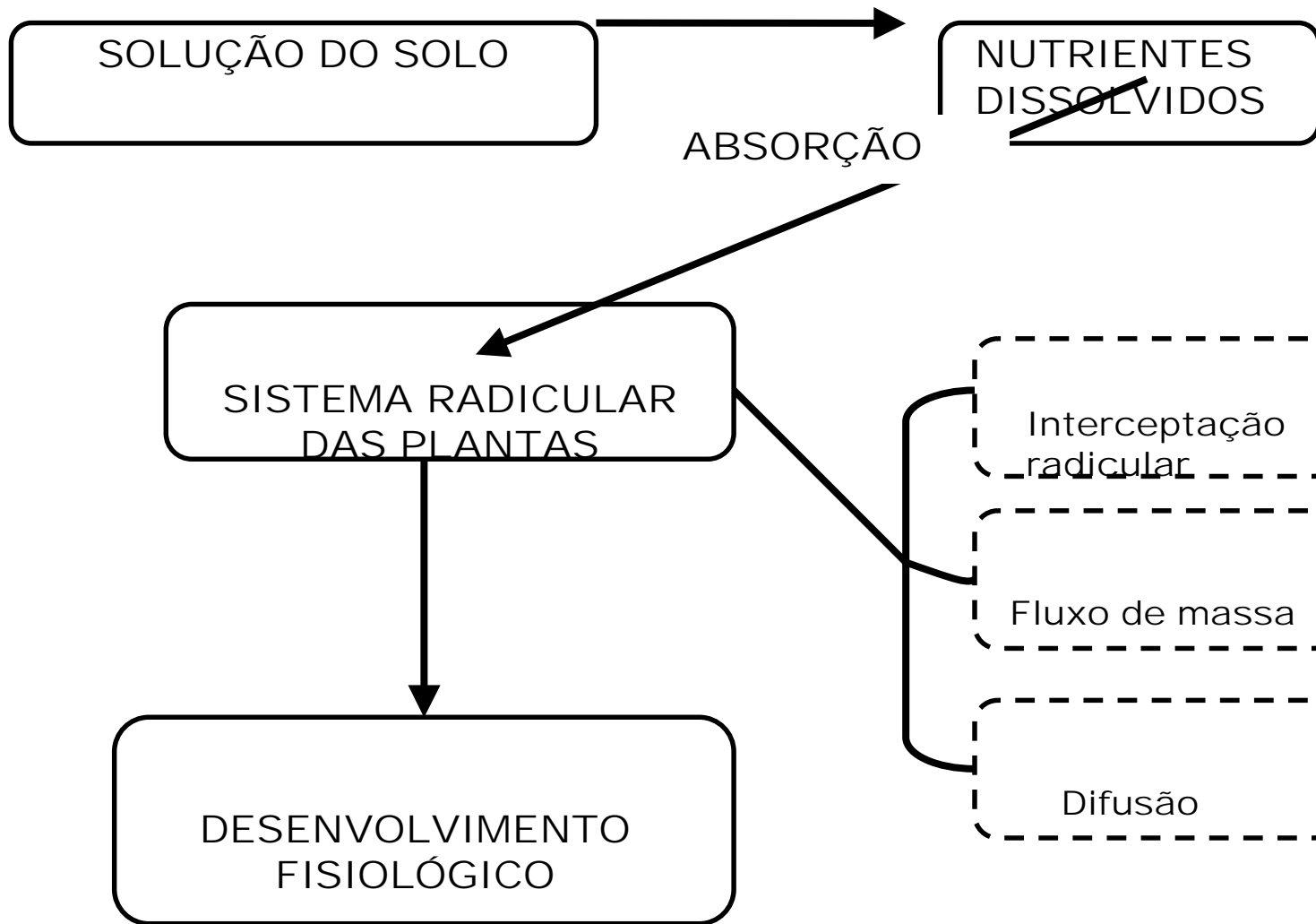

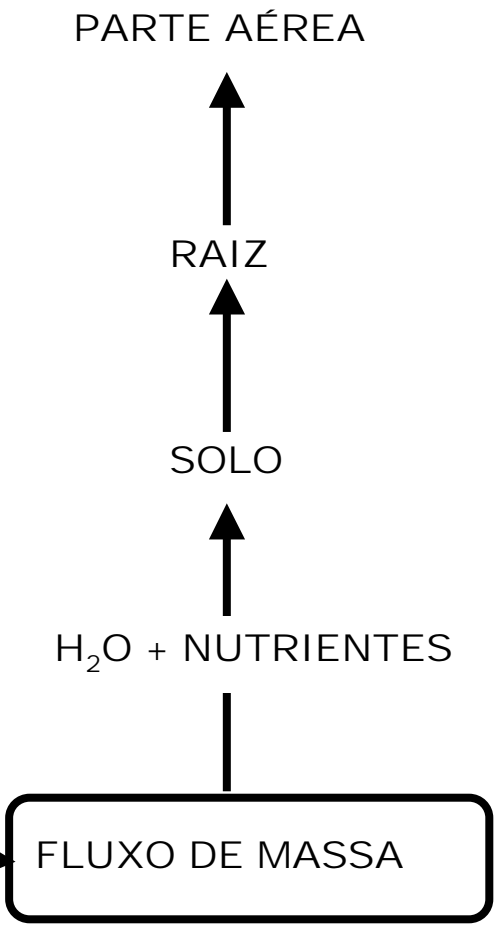
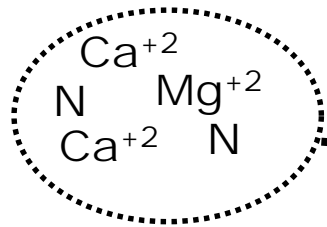
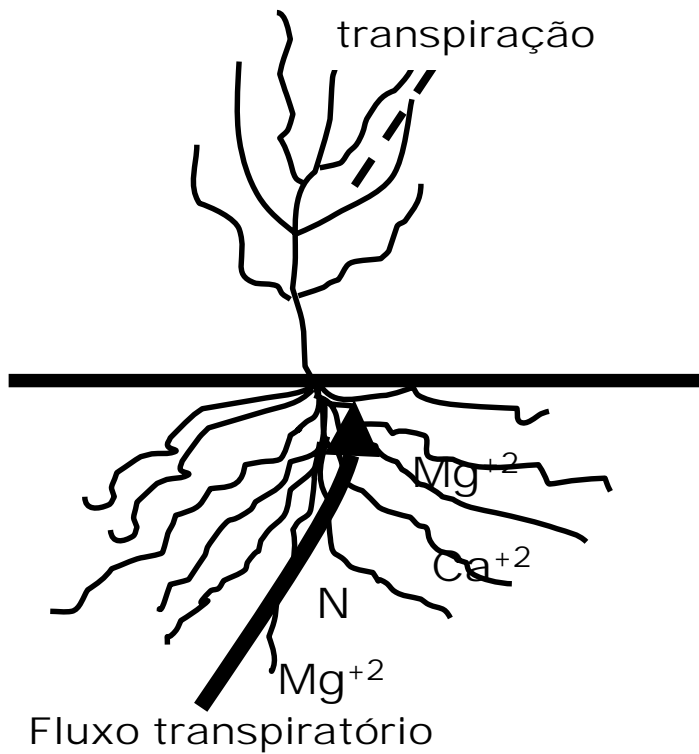

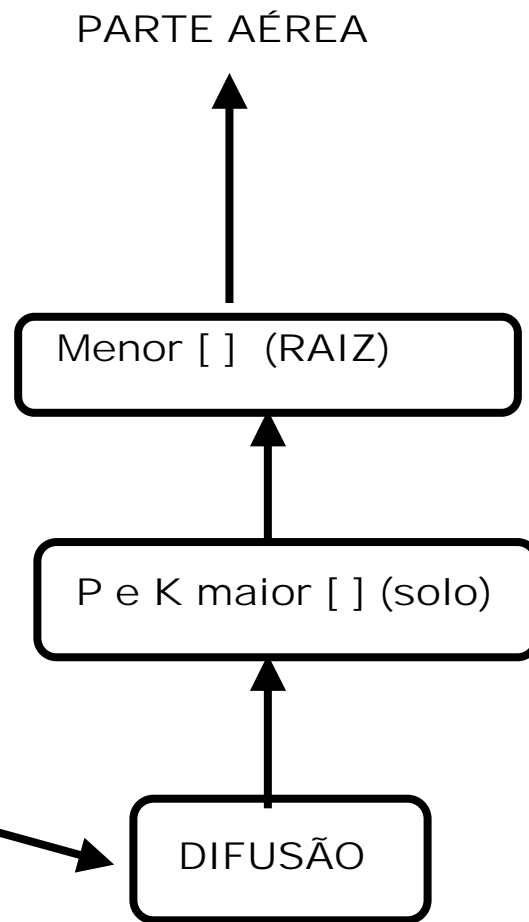
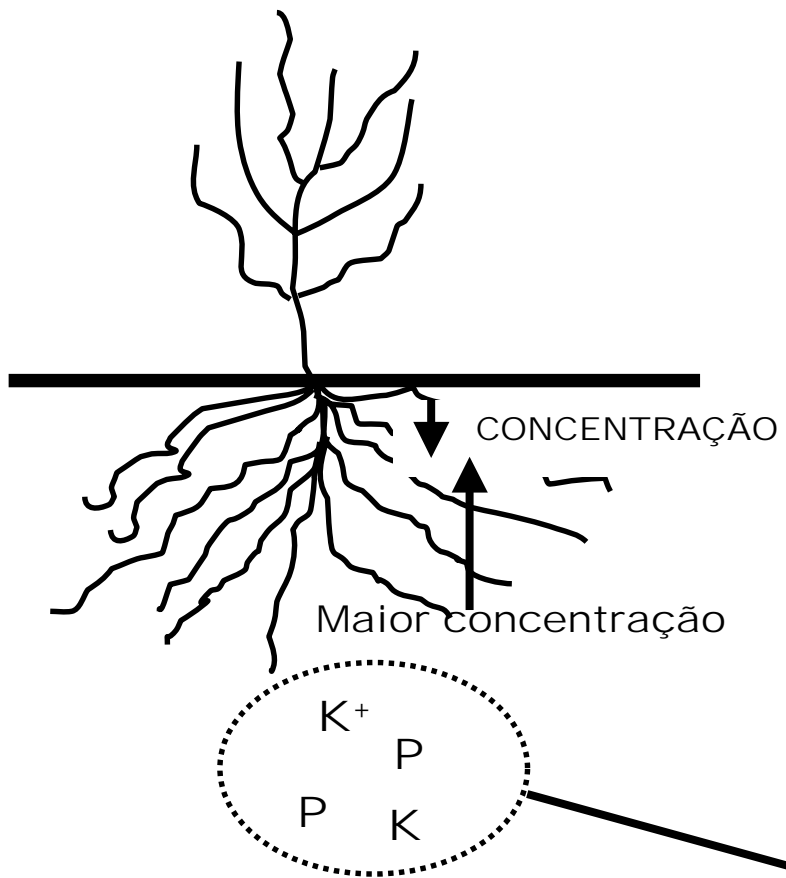

TEORIA DE ÁCIDOS E BASES DE ARRHENIUS

1) Ácidos e Bases de Arrhenius

. Ácido - Azedo - Acetarium

. Base - Alkali - Cinza de plantas

. Ácido: libera prótons em solução aquosa



➤ Base: libera hidroxilas em solução aquosa





Efeito da aplicação de fontes de N (150 kg ha⁻¹) em atributos de acidez

Tratamentos	pH do solo	Al ³⁺ (mmol _c dm ⁻³)
Sem N	6,2	0,0
Nitrocálcio	5,0	0,0
Salitre do Chile	5,8	0,0
Sulfato de Amônio	4,3	15,0
Uréia	4,4	9,0

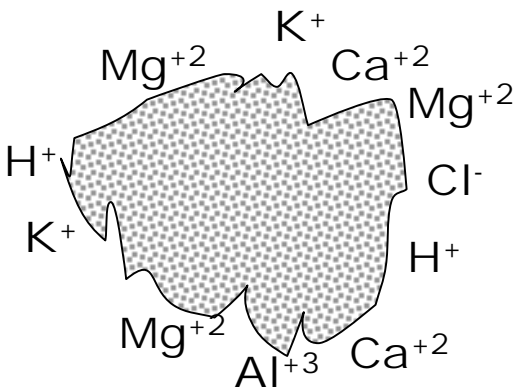

LIXIVIAÇÃO DE CÁTIONS

CULTIVO DO SOLO

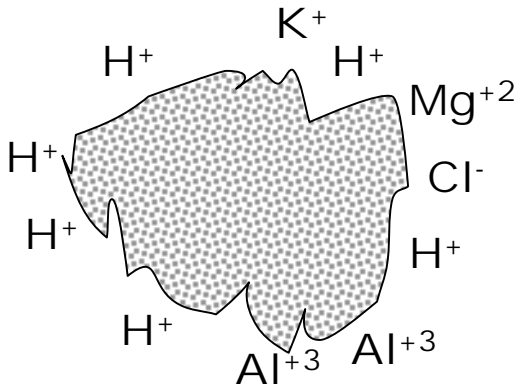

SOLO MAIS ÁCIDO

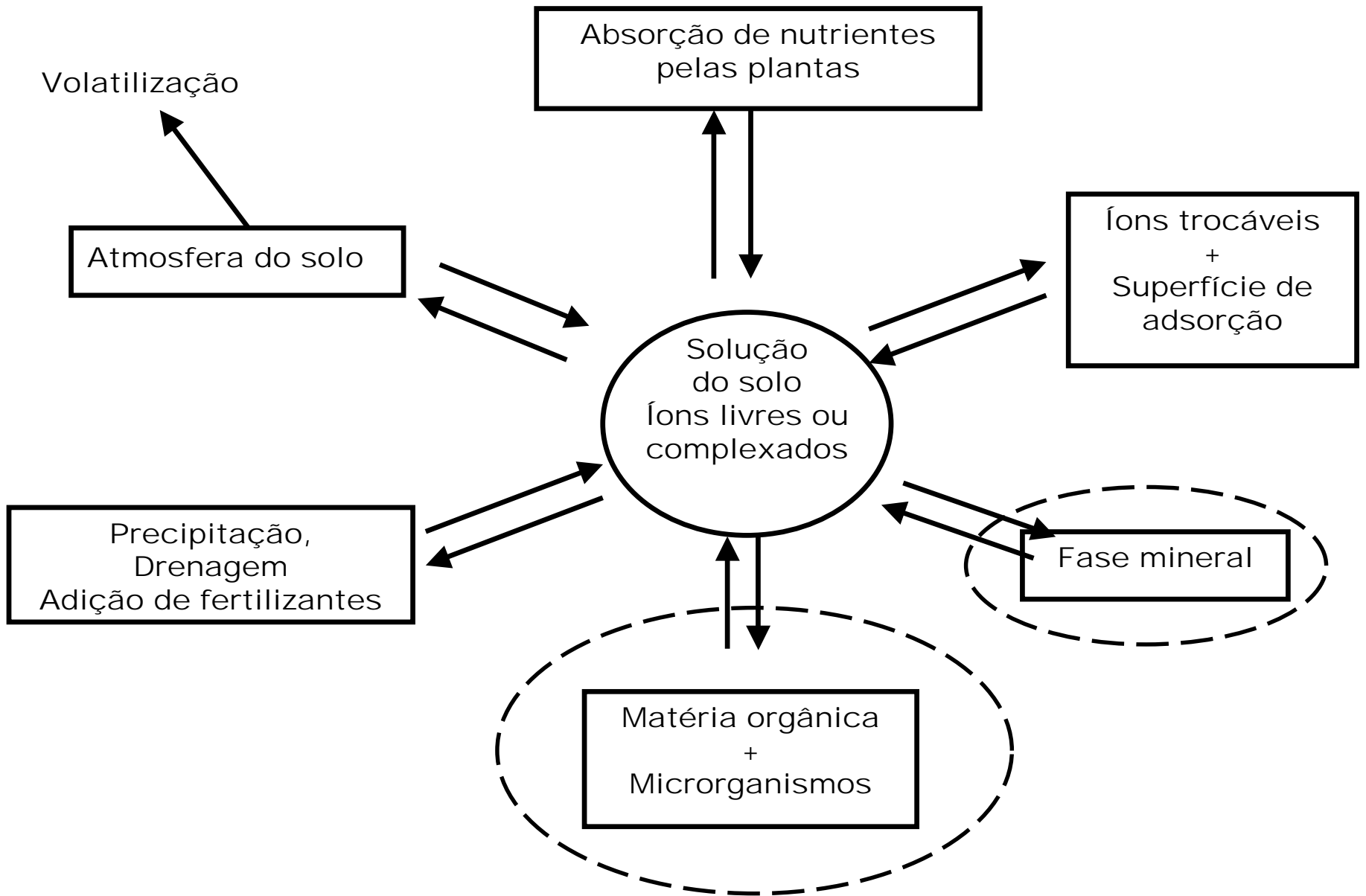

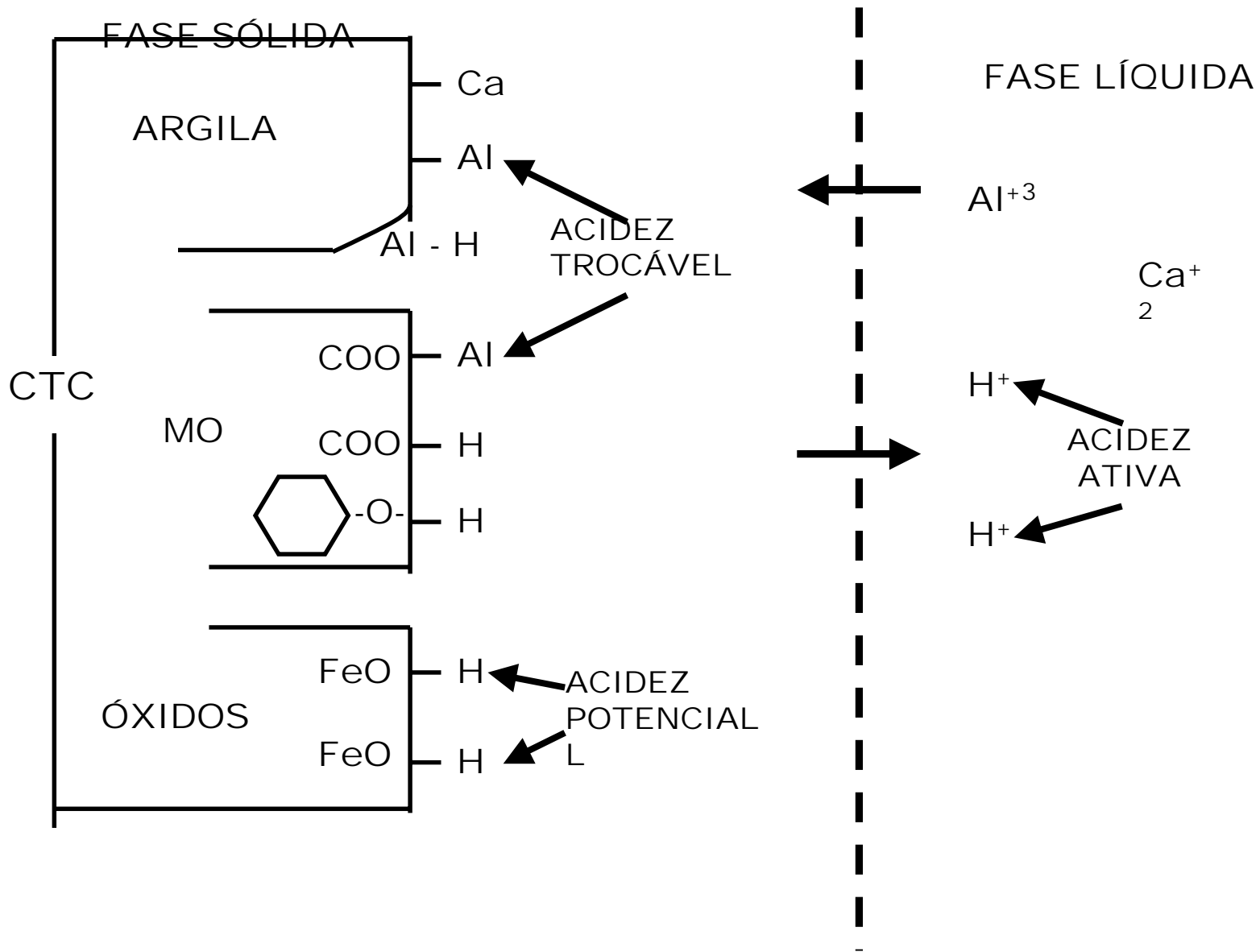

pH e H⁺Al

pH = Logaritmo negativo da concentração hidrogeniônica ou íon H₃O⁺

$$\text{pH} = -\log [\text{H}^+] = -\log [\text{H}_3\text{O}^+]$$

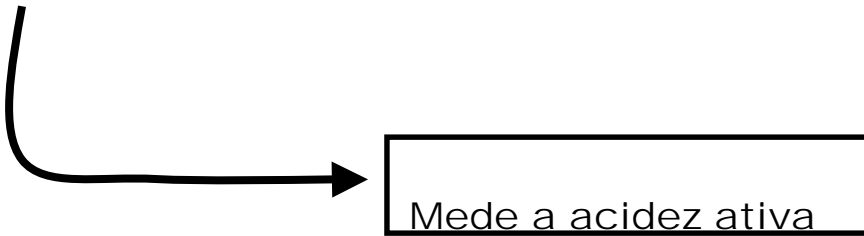

H⁺Al a pH 7,0 → Método do acetato de cálcio a pH 7,0
Solução Tampão SMP

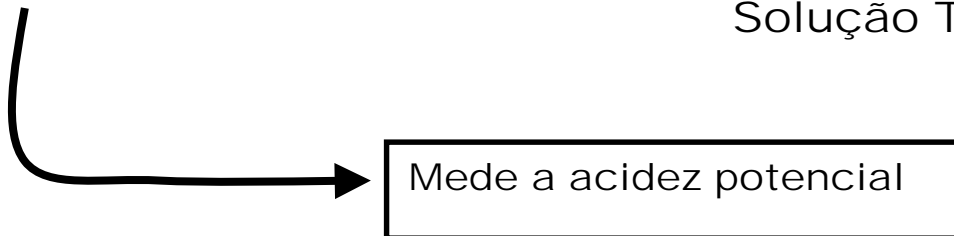

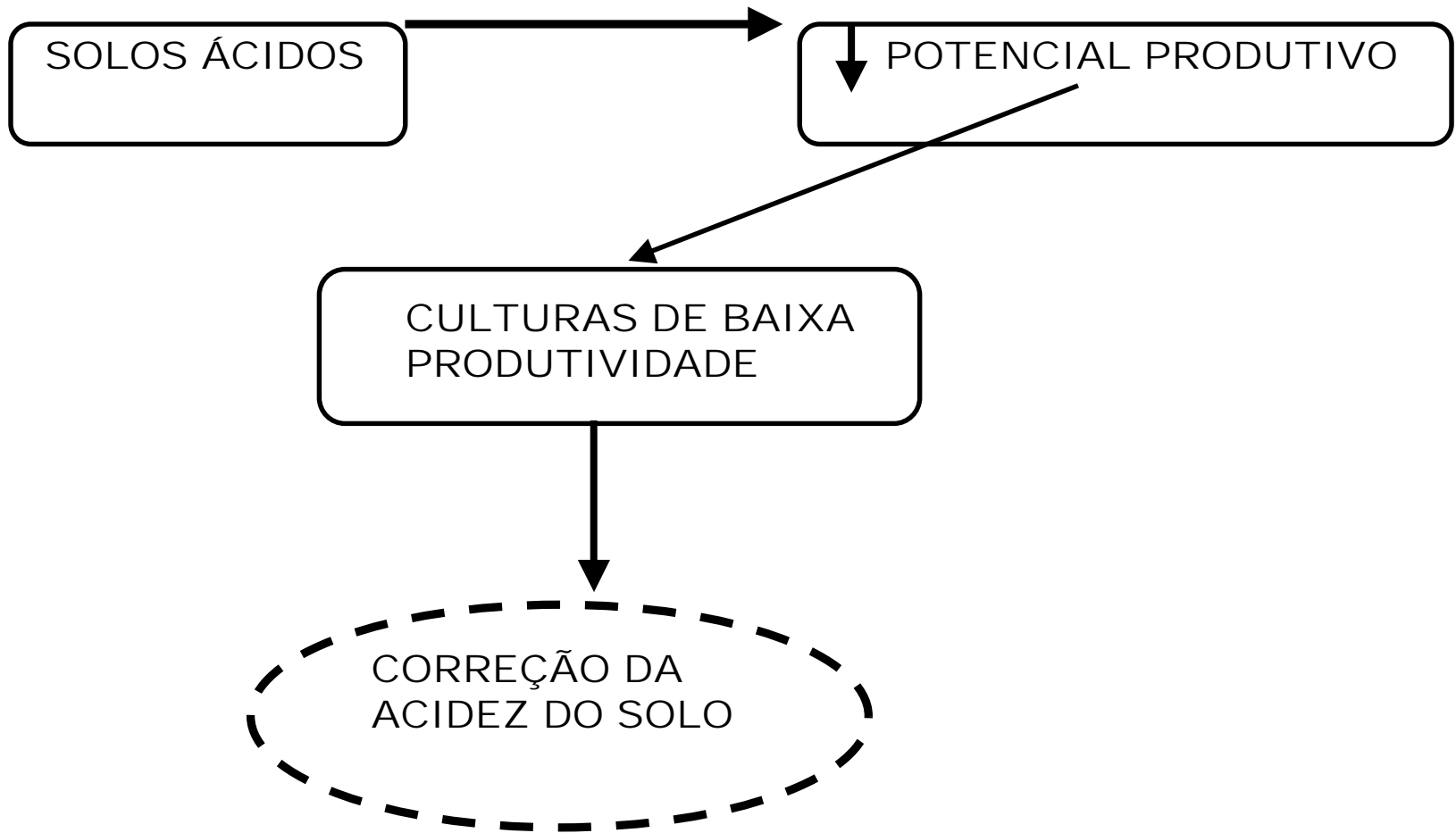

CORREÇÃO DA
ACIDEZ DO SOLO

SUBSTÂNCIAS - LIBERAM
HIDROXILAS (OH⁻)

MATERIAL MAIS UTILIZADO

CALCÁRIO

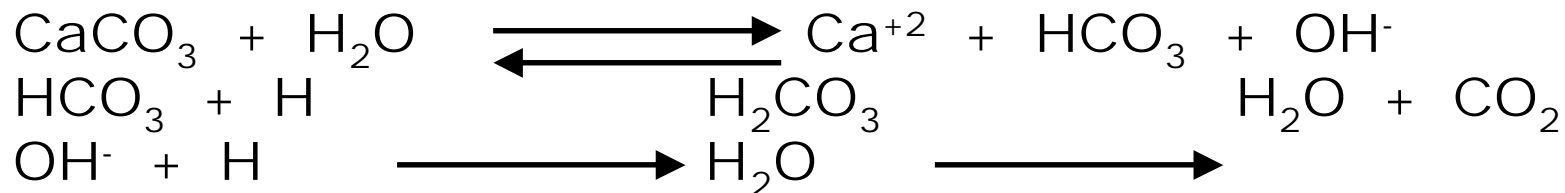

OH⁻ LIBERADOS REAGEM COM AL⁺³, Mn⁺² e H⁺
neutralizando a acidez

MODELO DE RECOMENDAÇÃO DE CALAGEM

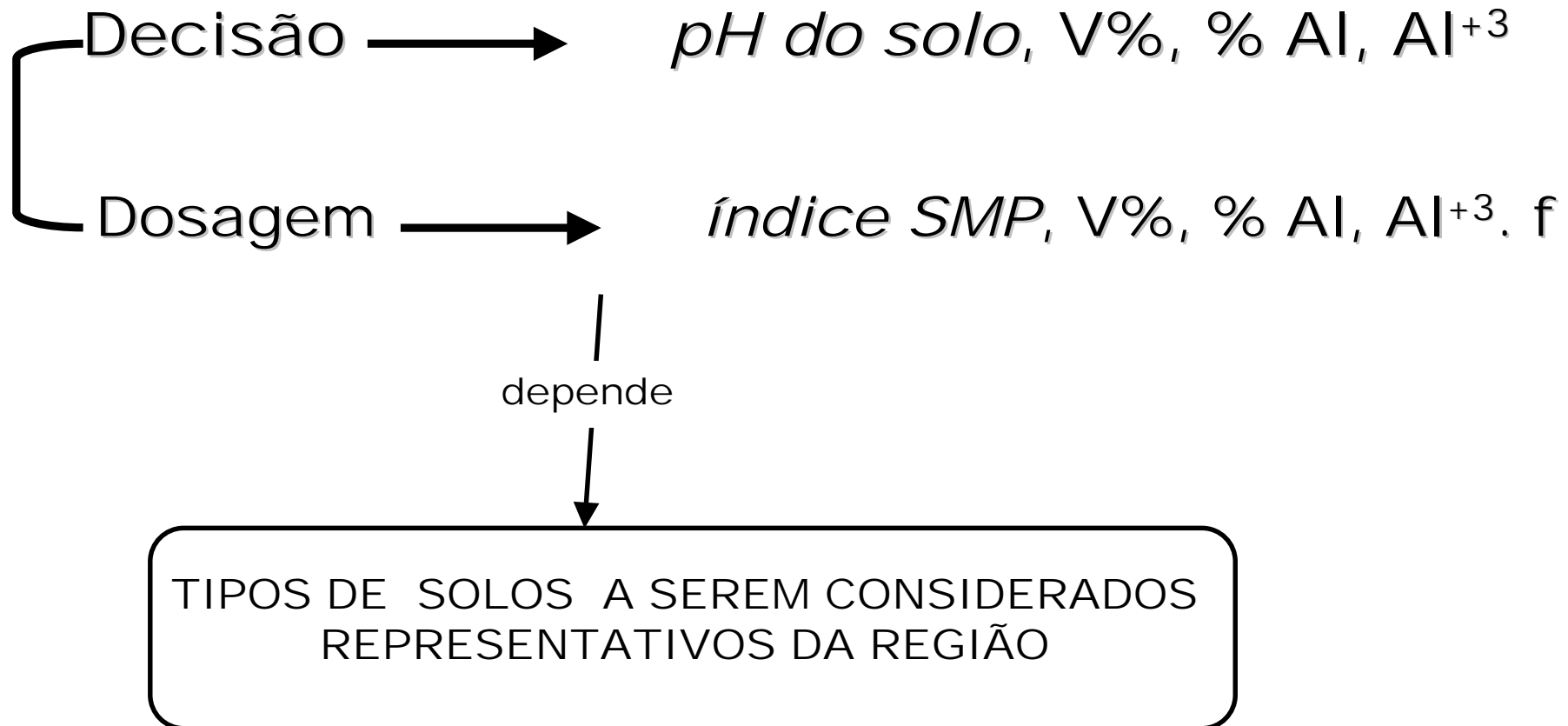

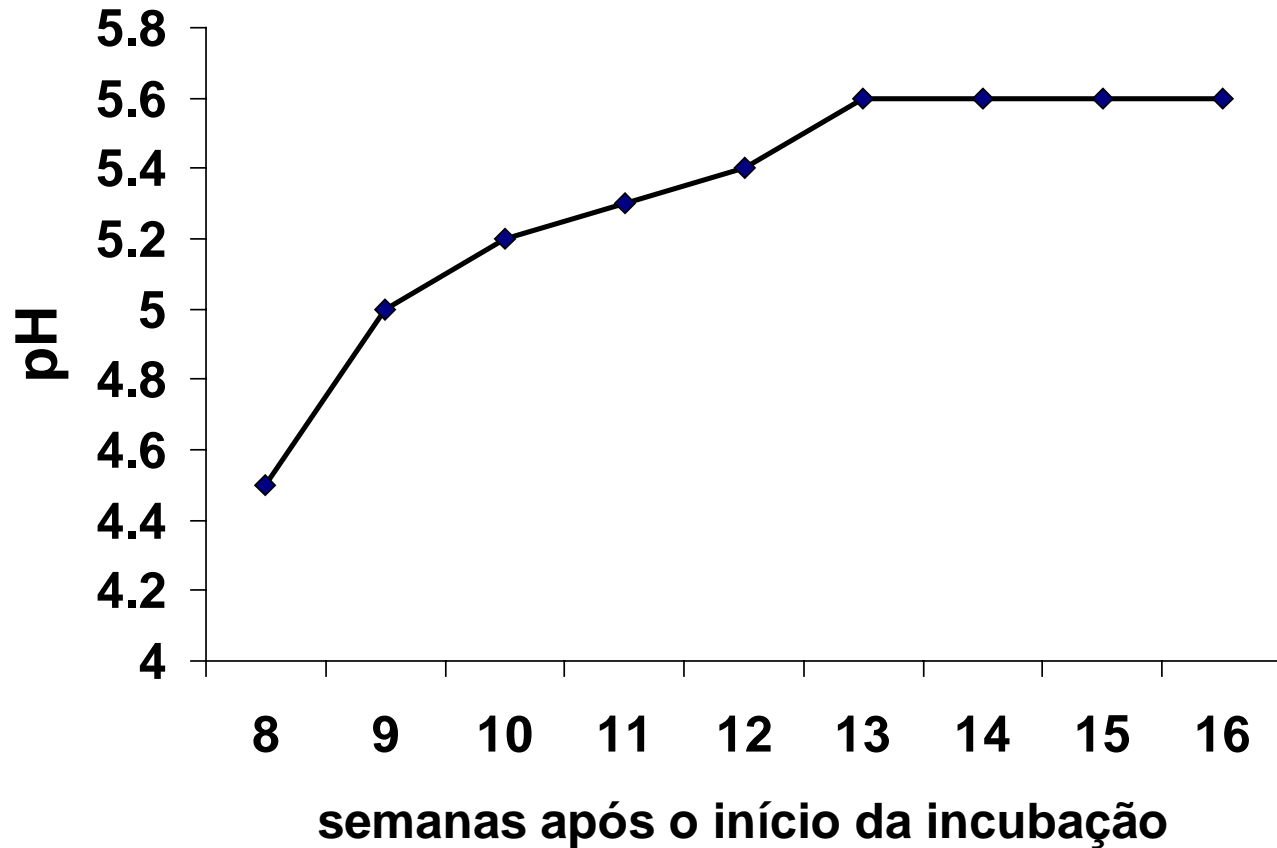

Valores hipotéticos de pH determinado após as várias semanas de incubação de um determinado solo onde foi adicionada de calcário.

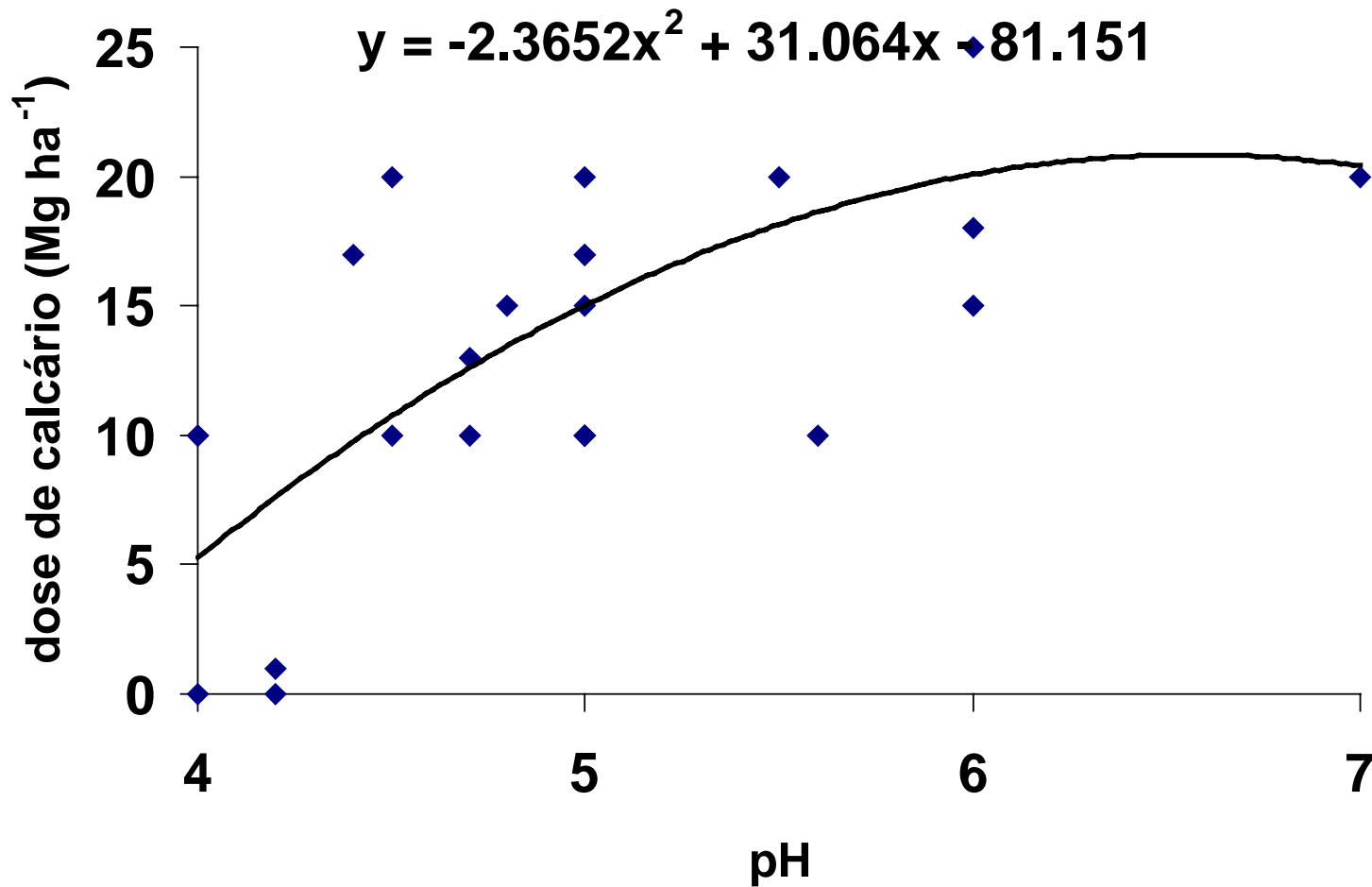

Curva de neutralização hipotética dos solos características

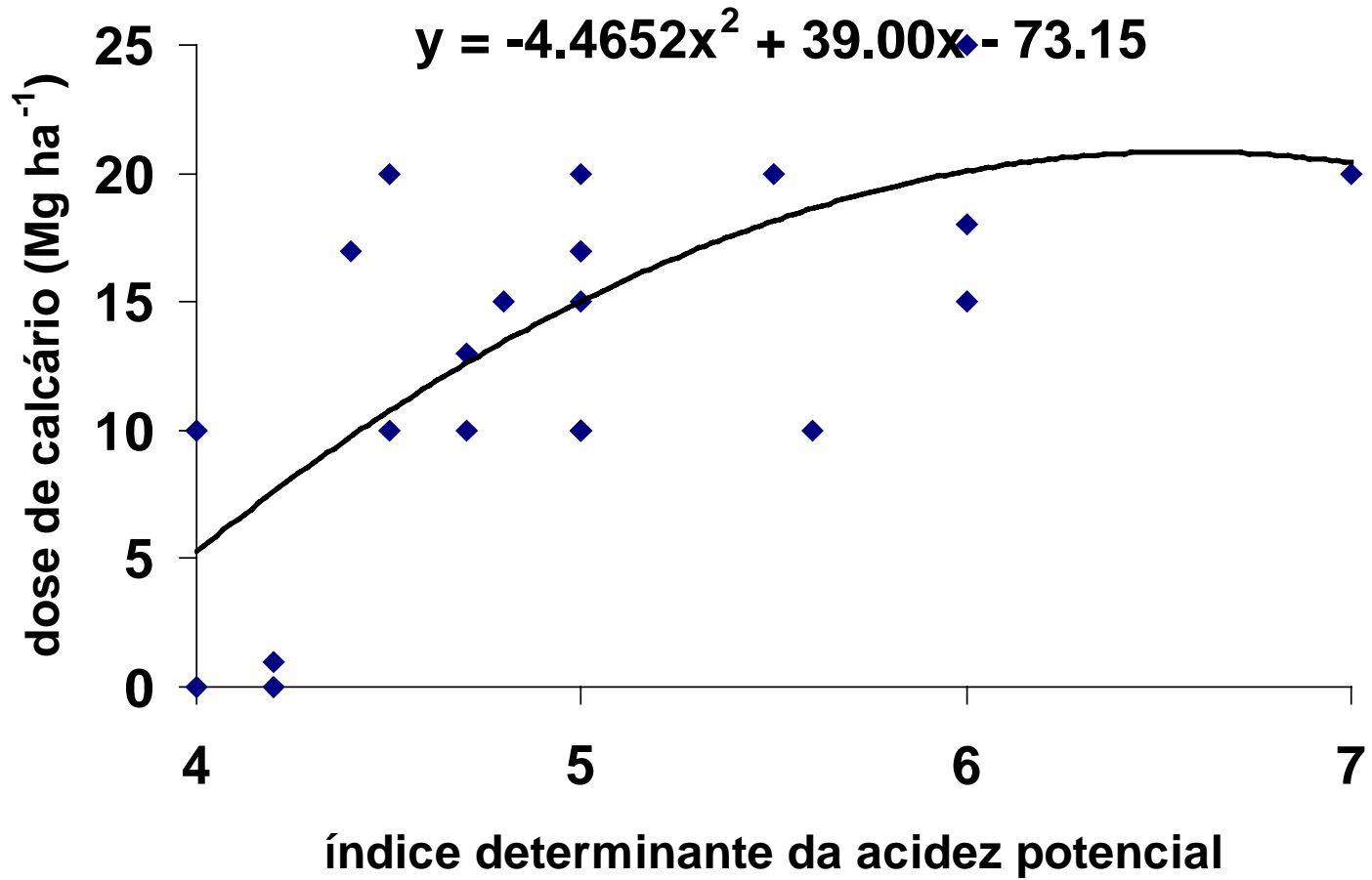

Curva de calibração hipotética dos solos característicos

ESTADO DE MINAS GERAIS

$$NC = \{ Y \cdot (Al^{+3} - (m_t \cdot t/1000)) \} + [x - (Ca^{+2} + Mg^{+2})] \}$$

NC = NECESSIDADE DE CALAGEM

Y = valor variável em função da capac. Tampão do solo

m_t = saturação máxima tolerada por determinada cultura

t = CTC efetiva em $cmol_c \, dm^{-3}$

x = valor variável - requerimento Ca e Mg pela planta

Acúmulo de matéria orgânica

```
graph TD; A[Acúmulo de matéria orgânica] --> B[Fonte de acidez]; B --> C[Quanto > AI E M.O.]; C --> D[> RECOMENDAÇÃO DE CALAGEM];
```

Fonte de acidez

Quanto > AI E M.O.

> RECOMENDAÇÃO DE CALAGEM

